

Dane techniczne:

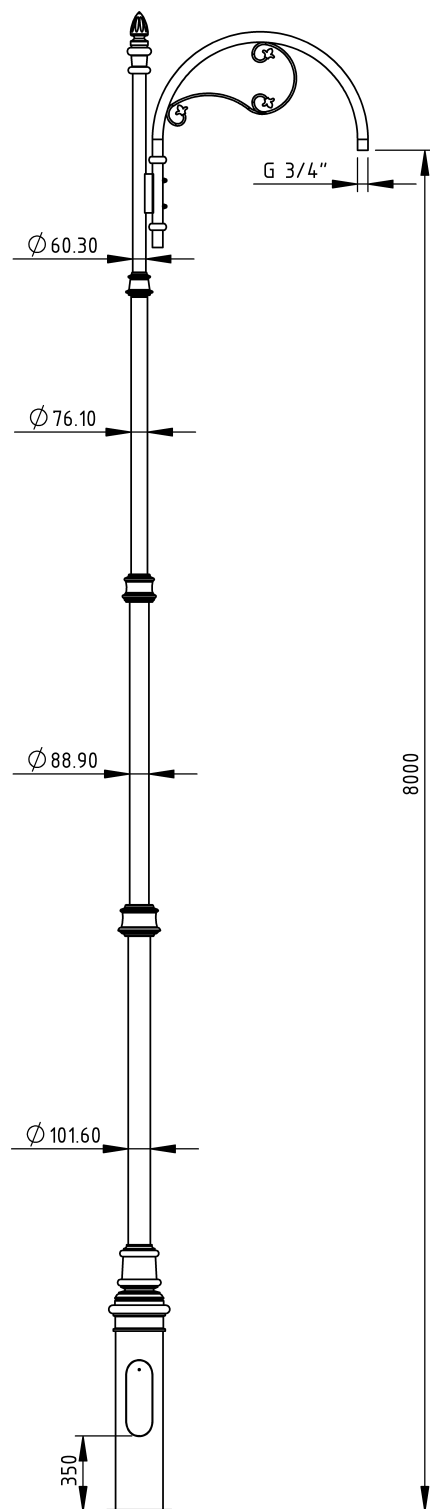

Wysokość słupa:	8 m
Elementy ozdobne:	odlew żeliwny lub stal
Montaż oprawy:	oprawa wisząca, zakończenie wysięgnika na życzenie klienta (standardowo GW 3/4")
Wykonanie:	materiał stal S235 lub S355 wg PN-EN 10025 cynkowanie ogniowe wg PN-EN ISO 1461 wykonanie wg normy PN EN 40-5
Klasa bezpieczeństwa biernego:	klasa 0
Wykończenie:	malowanie natryskowe lub proszkowe wg RAL opcjonalne powłoki na życzenie klienta
Wyposażenie opcjonalne:	złącze RST pod iluminację lub inne elementy systemów Smart City * możliwość umieszczenia herbu lub logotypu
Typ fundamentu:	F150

F150 wymiary

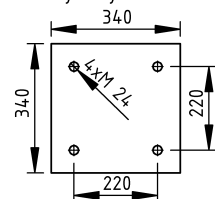

wymiary stopy słupa

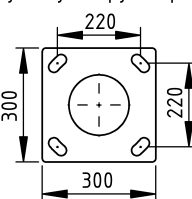

Producent:
Elgis-Garbatka Sp. z o.o.
ul.M.Wolfkego 8/41
01-494 Warszawa

Zakład produkcyjny:
Brzustów 61
26-930 Garbatka-letnisko



Dostępne wersje wysięgnikowe:

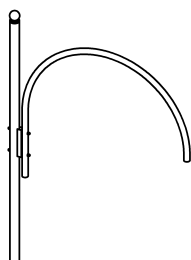

SPC-I-8/1/W3

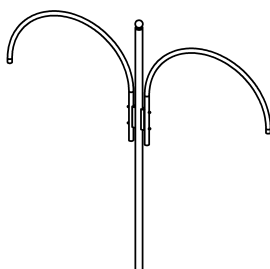

SPC-I-8/2/W3

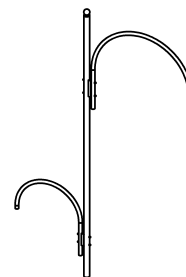

SPC-I-8/2.2/W3



SPC-I-8/1/W5

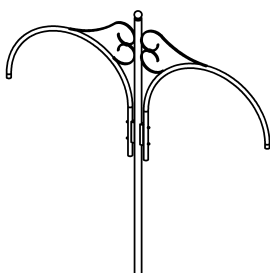

SPC-I-8/2/W5

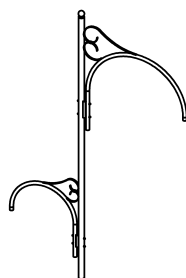

SPC-I-8/2.2/W5

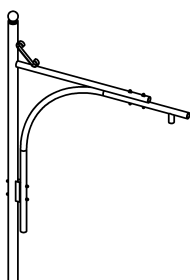

SPC-I-8/1/W6

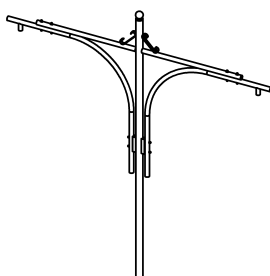

SPC-I-8/2/W6

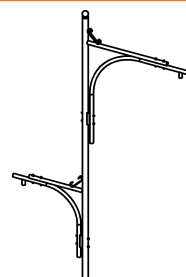

SPC-I-8/2.2/W6

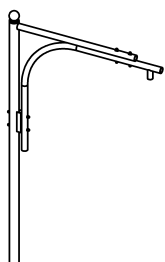

SPC-I-8/1/W7

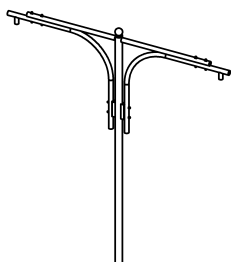

SPC-I-8/2/W7

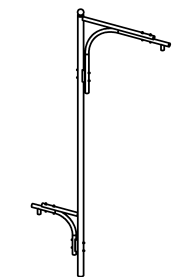

SPC-I-8/2.2/W7



SPC-I-8/1/W9

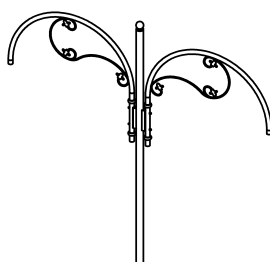

SPC-I-8/2/W9

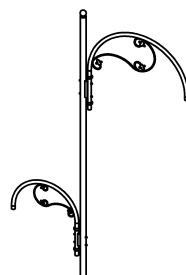

SPC-I-8/2.2/W9

Dostępne wersje wysięgnikowe:



SPC-I-8/1/W10



SPC-I-8/2/W10

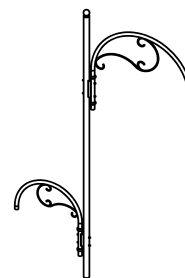

SPC-I-8/2.2/W10



SPC-I-8/1/W12

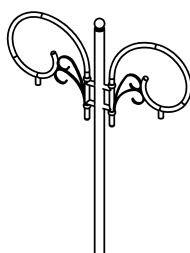

SPC-I-8/2/W12



SPC-I-8/2.2/W12

* Na życzenie klienta istnieje możliwość wykonania wysięgnika wg indywidualnego projektu

* Istnieje możliwość wykonania standardowych wysięgników w innej ilości i konfiguracji